

0 607 557 501

Issue } 08-12-12 **Fig./Abb. 2**
Stand }

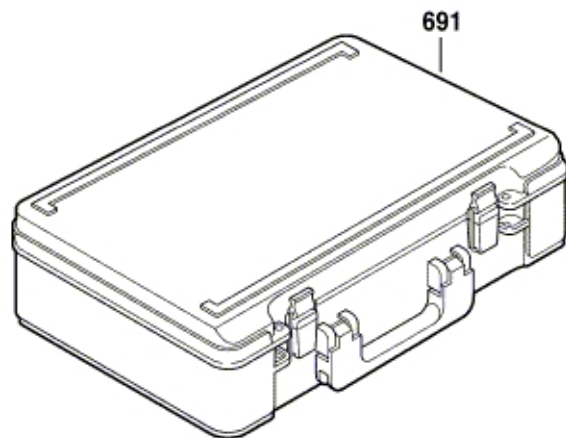
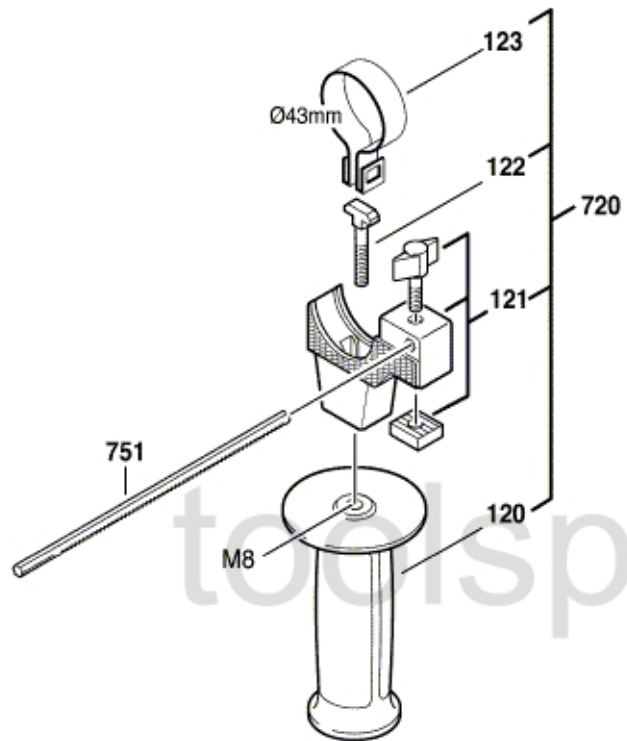

Änderungen vorbehalten
Modifications reserved
Modifications réservées
Salvo modificaciones